

Wunder-Bar™



ATTENTION
 Unplug the Dispenser's power cord from the electrical supply before removing any covers, making any adjustments, or performing any service on this dispenser.

Beverage Tower Dispenser
 For Dispensers with model number

WB-MU-(A)-(B)-(1)-(2)

Wunder-Bar

Mustang Tower

- (A) = 01: Clamp with Front Display
 02: Clamp with Front Display and Rear Display
 03: Countertop Mount with Front Display
 04: Countertop Mount with Front and Rear Display

- (B) = 01: No Drain
 02: Drain

- (1) = Number of Post-Mix BASE Beverages (0 to 8)
 (2) = Number of Flavor Concentrate Additives (0 to 8)

12V = , 8.5A

CONTENTS

PAGE NUMBER

Safety and Warnings / Sécurité et Avertissements.....	2
Overview.....	3-4
Mustang Installation.....	5-10
Mustang Operation.....	11-14
Start-Up.....	15-18
Sanitizing and Cleaning.....	19-20
Electrical Schematic.....	21
Installation Schematics.....	22-27

Wunder-Bar™

ATTENTION!

- Read all Instructions before setting up or operating the dispenser.
- This dispenser is not to be used by persons (including children) with reduced physical, sensory, or mental capabilities, or lack of experience or knowledge, unless they have been given supervision or instruction.
- Always disconnect the main power cord from the electrical source before removing any access panels or attempting to perform any servicing of this dispenser.
- **Caution, Risk of Electric Shock.** If the cord or plug becomes damaged, replace only with a cord and plug of the same type.
- **Caution, Risk of Electric Shock.** Do not operate the dispenser with a damaged power cord or if the equipment has been dropped or damaged—until it has been examined by a qualified service person.
- The dispenser should never be cleaned using a water jet nor installed in an area where a water jet is used.
- Service access panels should be removed by qualified service technicians, ONLY.
- Access to the service areas of this dispenser is restricted to qualified technicians with safety/hygiene knowledge, experience, and training for servicing this specific dispenser.
- Install and use this dispenser only as described in this instruction manual. Use only the manufacturer's recommended attachments.
- **This dispenser should be operated in the ambient temperatures: MIN: 2° C, 36° F MAX: 40° C, 104° F**

FCC Statement: This equipment has been tested and found to comply with the limits for a Class A digital device, pursuant to part 15 of the FCC Rules. These limits are designed to provide reasonable protection against harmful interference when the equipment is operated in a commercial environment. This equipment generates, uses, and can radiate radio frequency energy and, if not installed and used in accordance with the instruction manual, may cause harmful interference to radio communications. Operation of this equipment in a residential area is likely to cause harmful interference in which case the user will be required to correct the interference at his own expense.

IC Statement: This device complies with Industry Canada license exempt RSS standard(s). Operation is subject to the following two conditions: (1) this device may not cause interference, and (2) this device must accept any interference, including interference that may cause undesired operation of the device.

- Lire toutes les instructions avant d'installer ou d'utiliser le distributeur.
- Ce distributeur ne doit pas être utilisé par des personnes (y compris des enfants) ayant des capacités physiques, sensorielles ou mentales réduites ou un manque d'expérience ou de connaissances, à moins d'avoir reçu une supervision ou des instructions.
- Toujours débrancher le cordon d'alimentation de la source électrique avant de retirer les panneaux d'accès ou de tenter d'effectuer toute intervention de ce distributeur.
- **Attention, risque de choc électrique.** Si le cordon ou la prise est endommagé, remplacer avec un cordon et la prise du même type.
- Ne pas faire fonctionner le distributeur avec un cordon d'alimentation endommagé ou si l'équipement a été échappé ou endommagé, jusqu'à ce qu'il ait été examiné par un technicien qualifié.
- Le distributeur ne doit jamais être nettoyé avec un jet d'eau, ni installé dans une zone où un jet d'eau est utilisé.
- Panneaux d'accès aux services doivent être enlevés par des techniciens qualifiés, SEULEMENT.
- Accès aux zones de service de ce distributeur est limitée à des techniciens qualifiés de la sécurité / des connaissances d'hygiène, l'expérience et la formation pour l'entretien de ce distributeur spécifique.
- Installer et utiliser ce distributeur tel que décrit dans ce manuel d'instruction. Utilisez uniquement du fabricant les accessoires recommandés par.
- **Ce distributeur ne doit être utilisé dans les températures ambiantes: MIN: 2° C, 36° F MAX: 40° C, 104° F**

IC Déclaration: Le présent appareil est conforme aux CNR d'Industrie Canada applicables aux appareils radio exempts de licence. L'exploitation est autorisée aux deux conditions suivantes : (1) l'appareil ne doit pas produire de brouillage, et (2) l'appareil doit accepter tout brouillage radioélectrique subi, même si le brouillage est susceptible d'en compromettre le fonctionnement.

This equipment is rated for indoor use only. It will not operate in sub-freezing temperature. In a situation when temperatures drop below freezing, the equipment must be turned off immediately and properly winterized.

Removal from Service/Winterization

GENERAL

Special precautions must be taken if the dispenser is to be removed from service for an extended period of time or exposed to ambient temperatures of 32°F (0°C) or below.

CAUTION

If water or syrup is allowed to remain in the dispenser in freezing temperatures, severe damage to some components could result. Damage of this nature is not covered by the warranty.

WINTERIZATION PROCEDURE

1. Turn off the water and all syrup supply.
2. Disconnect and drain the incoming water line at the rear of the dispenser.
3. Blow clean, dry compressed air into all incoming water/syrup inlets and the drain openings in the bottom of the dispenser until no more water comes out the water/syrup valves or drain.
4. Make sure no water or syrup is trapped in any of the water or syrup lines or drain lines.
5. Disconnect the electric power at the circuit breaker or the electric service switch.

Cet équipement est conçu pour une utilisation en intérieur. Il ne sera pas fonctionner en sous-température de congélation. Dans une situation où les températures descendent en dessous de zéro, l'équipement doit être éteint immédiatement et correctement pour l'hiver.

Retrait du service / Hivernisation

GENERAL

Des précautions particulières doivent être prises si le distributeur doit être retiré du service pour une période de temps prolongée ou exposé à des températures ambiantes de 32 ° F (0 ° C) ou au-dessous.

ATTENTION

Si l'eau est autorisé à rester dans le distributeur en températures de congélation, de graves dommages dans une certaine composants pourraient en résulter. Les dommages de cette nature est ne sont pas couverts par la garantie.

PROCÉDURE HIVERISATION

1. Fermez le robinet d'alimentation et tous sirop.
2. Débrancher et vidanger la ligne d'eau entrant à l'arrière du distributeur.
3. Souffler de l'air comprimé dans l'ensemble entrants eau/ sirop entrées et les ouvertures de vidange dans le fond du distributeur jusqu'à ce que plus de l'eau sort les vannes d'eau / sirop ou de drain.
4. Assurez-vous pas d'eau ou de sirop est pris au piège dans une les conduites d'eau ou de sirop ou de lignes de drain.
5. Débranchez l'alimentation électrique au niveau du disjoncteur ou l'interrupteur de service électrique.

Wunder-Bar™

OVERVIEW



TOWERS WITH REAR DISPLAY
WB-MU-02-01 (BAR CLAMP W/ REAR DISPLAY)
WB-MU-04-01 (COUNTERTOP W/ REAR DISPLAY)



BASE TOWERS
WB-MU-03-01 (COUNTERTOP)
WB-MU-01-01 (BAR CLAMP)

The Mustang Tower can be configured to dispense 6 carbonated post-mix beverages, 2 non-carbonated beverages (tap water, carbonated water) and 2 Flavor Shots.
 Typical installation will have the Mustang counter-mounted with BIB Pumps and BIB storage rack located in the immediate area, such as, in the cabinet below or adjacent to the tower.

IMPORTANT!

**CARB & NON-CARB BEVERAGE APPLICATIONS:
 POTABLE WATER SUPPLY:**

Locate an existing potable water source with shut-off valve or have a licensed plumber install shut-off valve with 3/8" connection.

BACKFLOW PREVENTION REQUIRED!

Water pipe connections and fixtures directly connected to a potable water supply shall be sized, installed and maintained in accordance with federal, state, and local codes.

This beverage dispenser's water supply line must be connected to the potable water supply with adequate backflow prevention to comply with federal, state, and local codes.

GENERAL SPECIFICATIONS:

Inlet Water Pressure: Dynamic Water Pressure Range:
 25 to 95 PSI / 0.17 to 0.62 MPa
Maximum Static Pressure:
 100 PSI / 0.69 MPa

Voltage: 12V ~ , 8.5 A

Dimensions:

Model A: 8.00" W x 13.50" D x 16.00" H
 (Countertop) 20.32 cm W x 34.29 cm x 40.64 cm H
Model B: 8.00" W x 13.00" D x 21.25" H
 (Clamp) 20.32 cm W x 33.02 cm D x 53.98 cm H
Models A&D: 8.00" W x 13.50" D x 16.75" H
 (Countertop w/ Rear Display) 20.32 cm W x 34.29 cm x 42.55 cm H
Models B&D: 8.00" W x 13.00" D x 22.00" H
 (Clamp w/ Rear Display) 20.32 cm W x 33.02 cm D x 55.88 cm H
Shipping Weight: 35 Pounds / 15 Kilograms

Wunder-Bar™

OVERVIEW

PRE-INSTALLATION PLANNING

GENERAL:

Determine and confirm the appropriate location for mounting the Mustang Tower with the store manager. Typically, this will be the same location where all other soft-drink and beverage dispensers are located.

MUSTANG TOWER WITH DRAIN FITTING:

Ensure that the drain hose assembly is within distance of a drain according to federal, state, and local codes and regulations.

Fig. 1



BIB RACK LOCATION:

Determine where the BIB rack is located, if one already exists. If a BIB Rack does not exist, work with the manager to determine the optimal location for the new BIB Rack.

UNDER COUNTER (Fig.1):

Taking available space into account, locate the BIB Pumps and Rack in cabinetry directly below the Mustang Tower. Confirm that there is enough space available for a rack capable of holding 8 BIB containers.

ADJACENT ROOM OR STORE ROOM (Fig.2):

In most cases under counter storage space will not be available and the BIB Pumps and Rack storage rack must be located remotely, such as: in the next room or in a remote storage area, next to any existing soft-drink BIB Rack, if one exists. Run the syrup line bundle as appropriate according to federal, state, and local codes and regulations.

Fig. 2

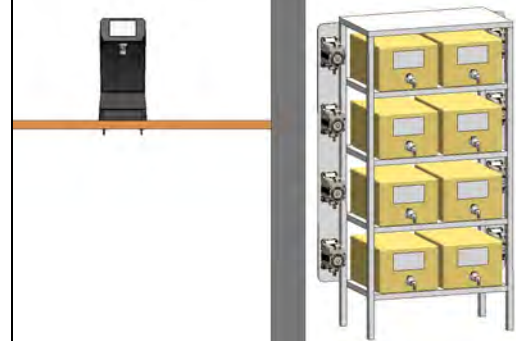

TOOLS REQUIRED:

- #2 Phillips screwdriver
- Oetiker clamp crimping tool
- Power drill
- Drill Bits (Size I, #29, 1 3/8" Step, Size F, 53/64")
- Keyhole Saw
- Brix Cup and 200 ml graduated cylinder
- Cup or pitcher
- Deburring Tool

ELECTRICAL INFORMATION:

- For a part of class III construction supplied from a detachable power supply unit, the instructions state that the appliance is only to be used with the unit provide.
- Instructions for class III appliances state that it must only be supplied at SELV.

Wunder-Bar™

USING CLIP REMOVAL TOOL TO INSTALL FITTINGS

1. To install the fittings, use the provided Clip Removal Tool (0506-371) to help lift the Kwik Klips.
2. Use the smaller end of the tool to hook under the desired Kwik Klip. See Figure 3.
3. Pull out to open the Kwik Klip.

I
N
S
T
A
L
L
A
T
I
O
N



4. To close the Kwik Klip after installing the fittings, use the same end to press the Kwik Klip back into place. See Figure 5.



Wunder-Bar™

INSTALLING A MUSTANG TO A COUNTERTOP: CONFIG. -03-XX and -04-XX

I N S T A L L A T I O N

1. Use the included drilling template to mark the Mustang Tower's five (5) mounting holes, drain hole, and tubing exit port onto the countertop surface. See Figure 6.
NOTE: Maximum countertop thickness is 2".
2. Drill out the mounting holes using the Size F drill-bit. To cut-out the tubing exit port, use a keyhole saw.
3. If installing a unit with a drain, use a #29 drill bit to create a pilot hole for the drain hole.
4. Install the provided fittings onto the appropriate syrup tubing using the provided Oetiker's Clamp.
5. Prior to installing the Mustang Tower onto the counter, insert the provided recirculation bundle into the appropriate ports (soda and water). Then, install the fittings and tubes from the previous step into the Mustang Tower.

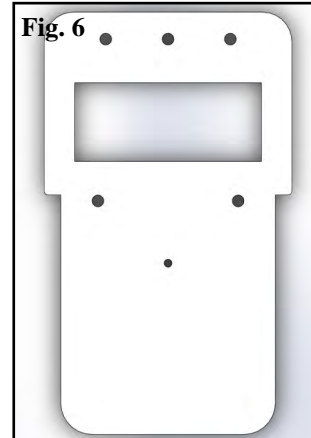

Fig. 6

5. Next, screw in the provided 1/4"-20 studs into the three (3) acetal rods and the two (2) threaded inserts on the bottom side of the Mustang Tower.
6. To mount the Mustang Tower to the counter, align the five (5) studs on the bottom of the Mustang with the five (5) drilled-out holes in the Countertop. While lowering the Mustang, make sure the tubes are lined up and do not cross each other. See Figure 7.



Fig. 7

7. Secure the Mustang Tower in place with the included hardware: 1/4 Washers and 1/4-20 Nuts.
8. Take the provided 1/4" Wire Loom (Wunder-Bar p/n MU-5K) and cut to appropriate length to cover any exposed threads. Cut any excess loom. See Figure 8.
9. Connect the water and syrup lines.

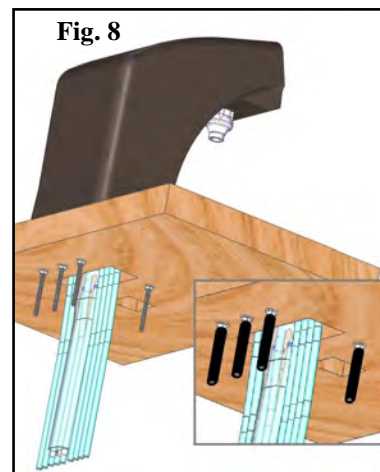

Fig. 8

Wunder-Bar™

INSTALLATION

CLAMPING A MUSTANG TO A BAR TOP— CONFIG. -01-XX and -02-XX

1. The bar clamp versions of the Mustang Tower do not require any cutting into an existing bar top. They are designed to clamp onto the front of a bar top.
NOTE: Maximum countertop thickness is 4".
2. Pre-install the provided input fittings onto the appropriately lengthened tubing. Then, install them into the Mustang Tower. Also, install the recirculation bundle to the appropriate ports (carbonated water and still water).

Fig. 9



3. Slide the Mustang Tower onto the front of the bar and tighten the bar-clamp by turning the knobs. Tighten until the Mustang Tower is fully mounted. See Figure 10.
4. Be careful to not overtighten the unit. If the tower starts to tilt forwards, then you have overtightened the unit.
5. Connect the water and syrup lines.
6. Take the provided 3/8" Wire Loom (Wunder-Bar p/n MU-3R-1) and cut them to length to cover the threaded rods so that they are not exposed. Make sure both sides of the threaded rods are covered.

Fig. 10

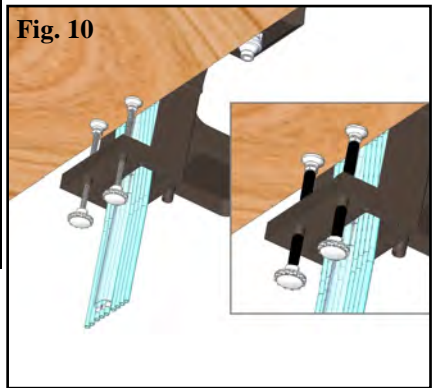

Wunder-Bar™

ATTACHING THE REAR DISPLAY— CONFIG. -02-XX AND -04-XX

INSTALLATION

1. The rear display can be attached to either base configuration and is sold as an add-on.
2. Unplug the power to the unit.
3. Remove the four (4) 6-32 screws securing the Rear Cover onto the Mustang Tower and the two (2) 4-40 screws near the Display Head. Set aside. Remove the four (4) 6-32 screws securing the Front Cover. Set aside.
4. Drill two holes using the size "I" drill bit at the two dimples closest to the flat portion of the rear cover on the inside of the cover.
5. Drill two (2) more holes using the #29 drill bit at the remaining two dimples on the cover.
6. Then, drill a hole at the square using a 1 3/8" step drill bit.

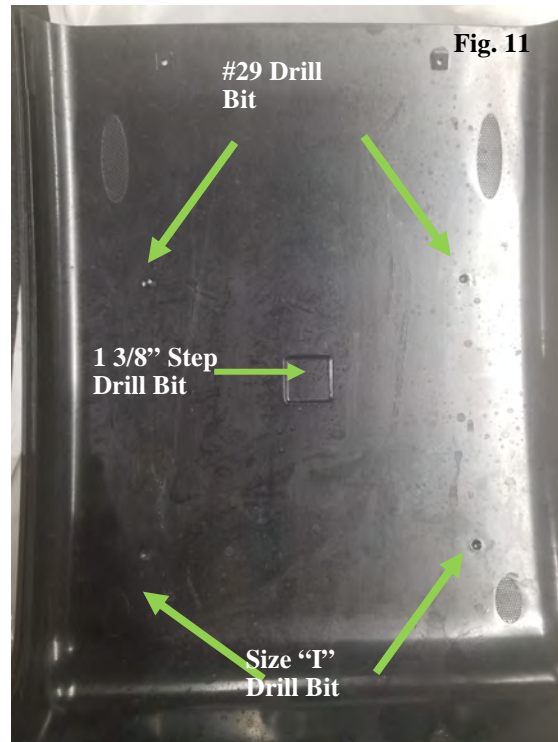

7. The finished part should look like **Fig. 12**. Deburr all drilled holes.
8. Fish the end of the USB cable and the green power cable coming from the Rear Display Assembly through the 1 3/8" hole so that the cables will be inside the unit. See Figure 13.
9. Line up the two bosses on the Rear Display Assembly with the two larger holes on the Rear Cover. Press them into the holes. The screen should be parallel with the flat surface on the Rear Cover.
10. Secure using the provided four (4) #4 washers and the four (4) #4-20 screws. Tighten until the Rear Assembly is flush with the back cover. See Figure 14.



Wunder-Bar™

INSTALLATION

ATTACHING THE REAR DISPLAY— CONFIG. -02-XX AND -04-XX

11. Connect the green connector with the label “Rear Display” with the green port on the display of the Rear Assembly. See Figure 15.
12. Fish the end of the USB through the front of the solenoids, then down the slot on the bottom of the housing the same way the power cord and the Front Display USB are done. See Figures 16 and 17.

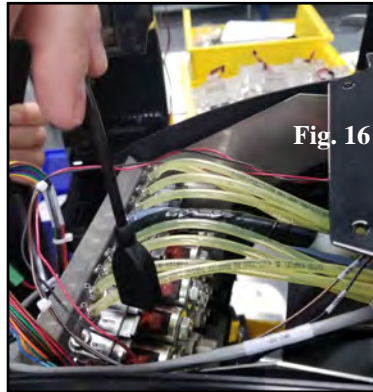
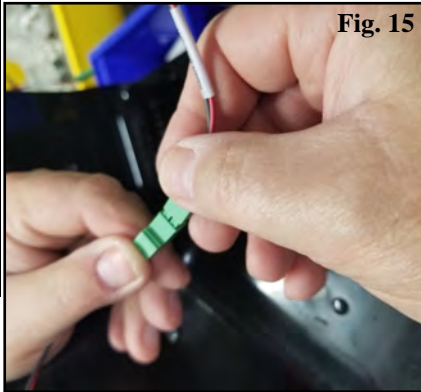

13. Re-attach the Rear Cover by tucking it underneath the tab of the Front Display. Secure using the screws previously set aside. See Figure 18.
14. Re-attach the Front Cover using the screws previously set aside.
15. The Rear Display should look like **Figure 19** after installation is complete. Ensure the connections are working properly by plugging in the power .



Wunder-Bar™

ATTACHING THE DRAIN FITTING — CONFIG. XX-02

I
N
S
T
A
L
L
A
T
I
O
N

1. The drain feature can be attached to either configuration.
2. Set the Drip Tray Basin down. Drill a hole using a 5/8" size drill bit at the center of the countersunk portion. See **Figure 20**.

Fig. 20



3. Unscrew the nut from the provided drain fitting and remove the metal washer and the rubber washer. Leave the white plastic washer on.
4. Slide the provided drain fitting through the hole so that the white washer will be sandwiched between the bottom of the drain fitting head and the basin. See **Figure 21** for the exploded view of the drain fitting and its parts.
5. Slide the rubber washer over the threaded part of the fitting. Then, slide the metal washer over the threaded part of the fitting. Tighten with the provided nut until the washers are sandwiched up against the drain fitting. See **Figure 21** for the correct order of parts.

Fig. 21



6. The drain fitting should be tight on the drip basin. **Figure 22** shows the bottom view of the assembly.

Fig. 22

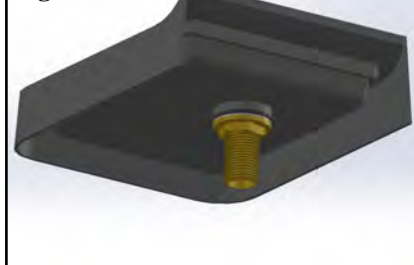

7. Use RTV Silicone around the edges of the fitting where it meets with the top-side of the basin to fill all the gaps. Let cure.
8. Screw on the provided 1/2" NPT to 3/4" Barbed Fitting. See **Figure 23**.
9. Attach the provided Drain Hose Assembly by sliding on the hose clamp and sliding the hose over the barbed portion of the drain fitting. Secure using the hose clamp.
10. For WB-MU-03-02 and WB-MU-04-02, place the drip tray basin into the rim. Then, apply a small bead of RTV Silicone around the bottom edge where the basin meets the countertop.

Fig. 23



Wunder-Bar™

OPERATING STANDARD

OPERATION

Normal operation mode:

1. Initialization

Connect the power supply harness to the power supply.

Do not touch any area of the Touchscreen during the Startup Sequence.

2. Beverage dispensing (up to 8 Brands) for SELF-SERVE

A. The normal operating screen will look like **Fig. 24**.

B. Press any brand to enter the Dispense Beverage Screen.

- i. For systems without flavor additives: Press and hold the brand button to dispense the selected beverage. Release the brand button to stop dispensing the selected beverage.

Fig. 24



C. Select and dispense the desired Beverage

- i. For systems with flavor additives (not available on 8 Brand):
 - a. Select the desired flavor(s). More than one flavor can be selected at a time (**Fig. 25** shows both VANILLA and STRAWBERRY being selected).
 - b. Press and hold the POUR button. Release to POUR button to stop dispensing.

Fig. 25



The programmable maximum Dispense interval is 30 seconds (60 ounces).

Fig. 26



Wunder-Bar™

OPERATING STANDARD

OPERATION

3. Beverage dispensing (up to 8 Brands) for CREW SERVE

A. Press any brand to enter the Dispense Beverage Screen.

Fig. 24



B. Select and dispense the desired Beverage:

- i. For systems with flavor additives: select the desired flavor, then press next. See Fig 27.
- ii. For systems without flavor additives: select the brand.

Fig. 27

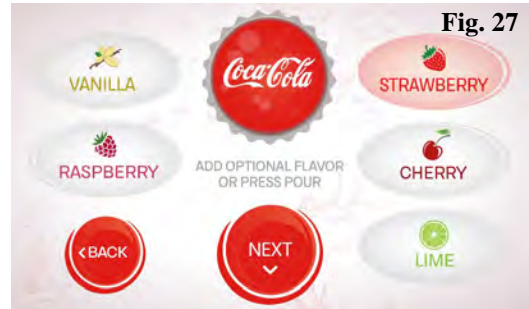

C. Select the size and drink type (ice or no ice) to begin dispensing. The unit will dispense the correct volume and does not need to be held. In Figure 29, the "Small No Ice" is being selected.

- i. If the dispensing needs to be stopped, select the "STOP" button in the upper right-hand corner.

D. If the drink needs to be topped off, select the "MANUAL TOP-OFF" button on the lower left-hand corner. Press and hold until desired amount is dispensed. See Figure 30.

Fig. 28

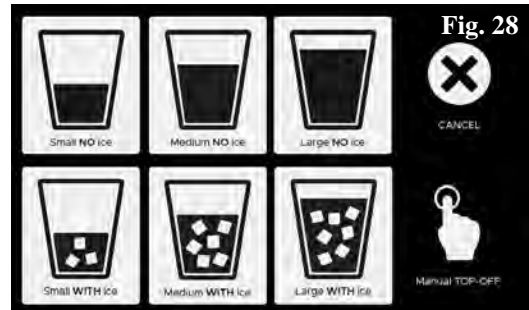

Fig. 29

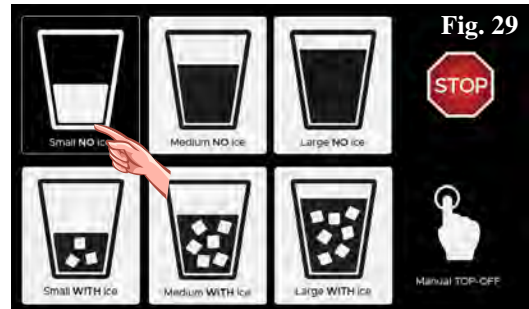
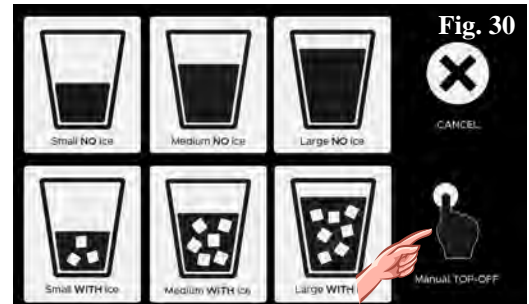

Fig. 30



The programmable maximum Dispense interval is 30 seconds (60 ounces).

Wunder-Bar™

OPERATION

OPERATING STANDARD

4. Store Manager Mode:

A. Use this mode to lock any brands from dispensing.



B. Enter the Store Manager Screen:

- i. Tap into the PIN pad screen by pressing the top corners in the sequence 1-1-2-1 as in Figure 31.
- ii. When the PIN pad appears, type in “2-1-6-5” to enter the Store Manager Service Screen.

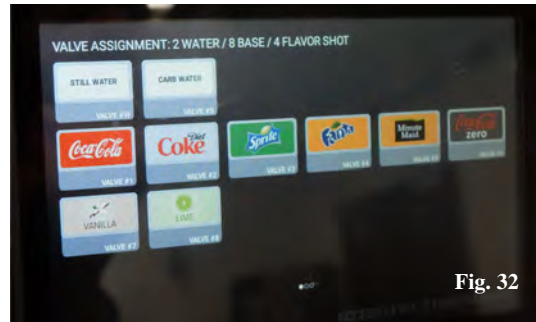

C. Select the desired beverage to lock dispense. Then, select “Lock Beverage” and “Confirm Lock”. See Figures 32, 33, and 34.

D. Exit the screen and the selected beverage should say “Out of Stock”. See Figure 35.

E. When the beverage is in stock again, follow the same instructions, but with the buttons will now say “Unlock Dispense”.

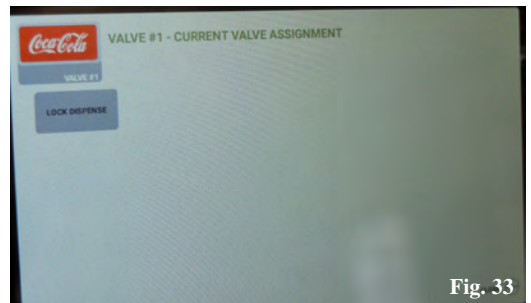

Wunder-Bar™

OPERATING STANDARD

OPERATION

5. Modifying Portion Settings

A. Use these settings to modify portion settings and configure auto top-off settings. This is only available in crew-serve mode.

B. Enter the Service Technician Screen:

- i. Tap into the PIN pad screen by pressing the top corners in the sequence 1-1-2-1 as in Figure 31.
- ii. When the PIN pad appears, type in "1-7-6-6" to enter the Service Technician Screen. Swipe left to the second screen. See Figure 37.

C. Select "Portions Adjustment" to modify the portion sizes (small, medium, and large; with and without ice). This will set the first dispense time of the product. See Figure 38.

D. Move the slider to adjust the pour duration as necessary. Exit when finished.

E. To activate the auto top-off feature, return to the previous screen. then, select "Enable Auto Top-off".

F. Select "Auto Top-off Adjustments" to change the wait time between dispenses for each brand. See Figure 39.

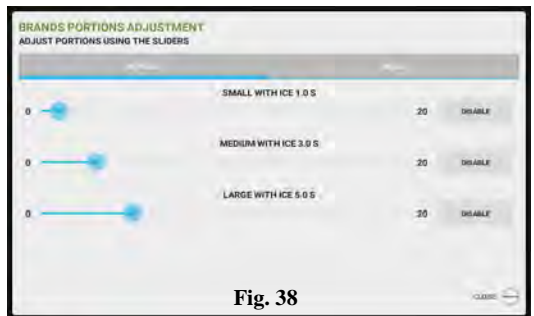

Wunder-Bar™

**S
T
A
R
T
U
P**

CALIBRATION AND SETTING CHANGES:

Flow rate calibration and certain setting changes are performed in the following mode:

1. Flow Calibration Mode:

There are 4 “hidden” buttons on the Dispense Screen which must be entered in proper sequence to enter the Service Screen.

- A. Press the 4 corners in the correct sequence: Top Left, Top Left, Top Right, Top Left (1,1,2,1). See Figure 31.
- B. If successful, a PIN-Pad will appear. Input 1-7-6-6.



- C. A new screen should appear telling you what your options are. Select “Pepsi”. See Figure 40.

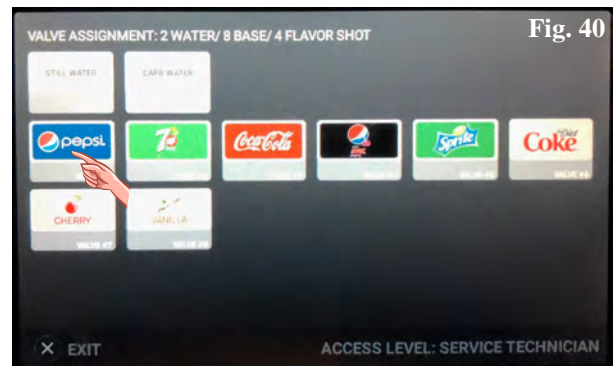

- D. Select “Prime/ Brix Calibration”. See Figure 41.

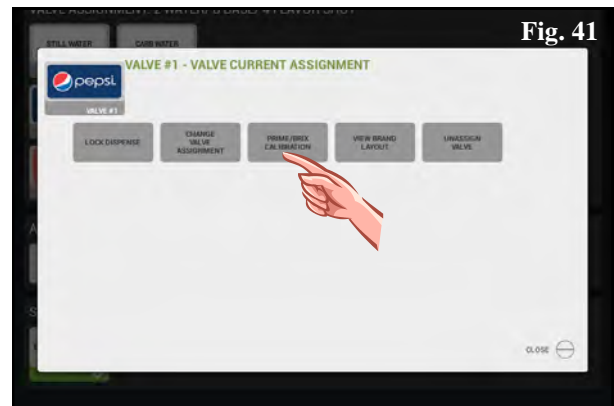

Wunder-Bar™

STARTUP

CALIBRATION AND SETTING CHANGES:

Flow rate calibration and certain setting changes are performed in the following mode:

E. Press and hold the “Prime Dispense” Button to prime the lines. Make sure that air is purged completely from the line before moving on to the brix calibration. See Figure 42.

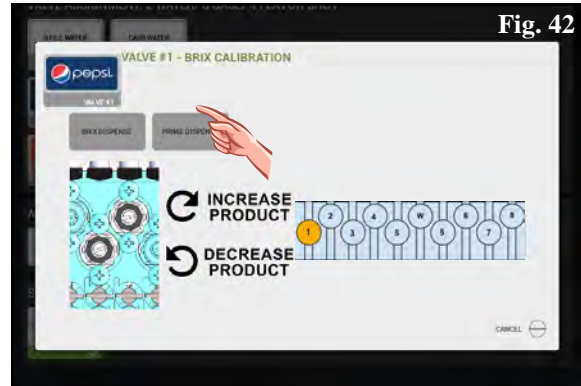

F. Press the “Brix” Button to begin a 4 second dispense. See Figure 43.

RECOMMENDED SETTINGS:

1. Syrup Circuit 1— Available
2. Syrup Circuit 2—Available
3. Syrup Circuit 3—Available
4. Syrup Circuit 4—Available
5. Syrup Circuit 5— Available
6. Syrup Circuit 6—Available
7. Syrup Circuit 7—Available
8. Syrup Circuit 8—Available

Mustang Tower @ 4 seconds

Ratio	Syrup (ml)	Water (ml)
5	40	200
5.5	37	
6	33	
8.5	24	
30	7	

Soda = 200 ml*
Water = 200 ml*

*Soda and Water (if connected) setting must be identical



- G. Check dispensing volume against specified volume. Adjust flow rate if necessary. **Adjust Flow Controls in 1/8 to 1/4 turns.** See ADJUST FLOW CONTROLS on the following page.
- H. Press “CANCEL” to stop any dispensing immediately.
- I. PRESS “EXIT” to exit Service Screen.

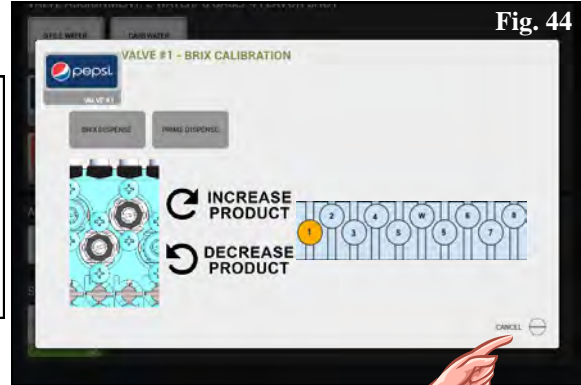

2. Ratio Timing:

- A. An alternative brix calibration module which enables the user to check the flow rate of channels W and S with a 3-second dispense. See Figure 45.
- B. Ratio Timing also provides three additional features that can be applied to any dispensing channel: Prime (touch-and-hold dispense), Open (dispense until cancelled), and Brix (6-second dispense).



Wunder-Bar™

**S
T
A
R
T
U
P**

ADJUST FLOW REGULATORS

1. To gain access to the syrup, carbonated water, and still water flow regulators, remove the four screws located on the front cover and set aside. See Figure 46.

Fig. 46

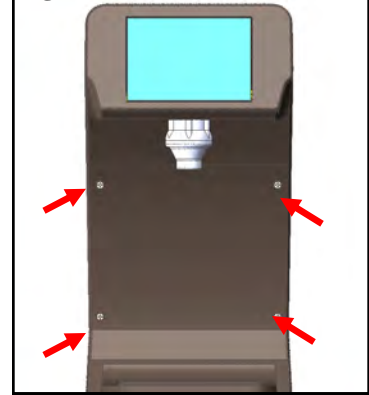

2. Lift the lower part of the cover up and away from the tower. See Figure 47.

Fig. 47



3. Adjust the 1 through 8 Flow Adjusting Screws as necessary. Adjust Syrups 1 through 8 to the fluid amounts listed in the cart on the page 12.
4. If the amount of syrup is not the same as listed in the chart on page 12, loosen the Lock Nut and use a flat blade screwdriver to adjust the appropriate Flow Regulator.
5. Turn the Adjusting Screw **CLOCKWISE to INCREASE** the amount of syrup dispensed or **COUNTERCLOCKWISE to DECREASE** the amount of syrup dispensed.



Wunder-Bar™

S
T
A
R
T
U
P

CALIBRATION AND SETTING CHANGES

3. Enabling/Disabling Multi-Flavor:

- Enter the service technician screen as detailed in the **Flow Regulator and Calibration Settings** section.
- Swipe the screen to the left to get to the second page and select the “Enable Multi-Flavor” feature if the unit can dispense multiple flavors at once. See Figure 49.
- Click the exit button to return to the main screen.

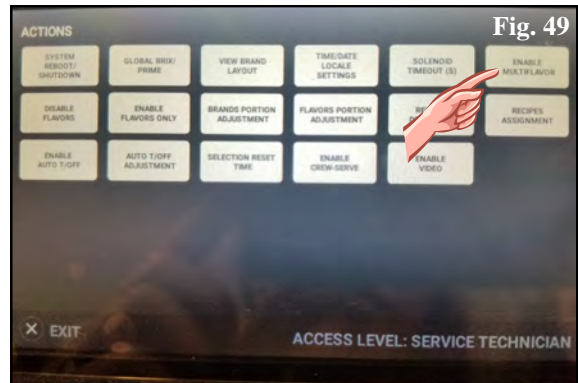

- Select a brand and select more than one flavor to ensure that the unit is working properly. See Figure 50.



Wunder-Bar™

C
L
E
A
N
I
N
G

I
N
S
T
R
U
C
T
I
O
N
S

MUSTANG DISPENSING SYSTEM CLEANING INSTRUCTIONS

EQUIPMENT NECESSARY

- Clean 5 gallon bucket
- Clean 2-1/2 to 5 gallon bucket (Catch Container)
- Safety goggles and rubber gloves
- Acceptable Sanitizing Solution (see **CLEANING SOLUTION** below for example of acceptable sanitizer)

WARNING!

DO NOT USE LAUNDRY TYPE LIQUID BLEACH AS A SANITIZER!!

CAUTION: Chlorinated Sanitizers are corrosive. Wear rubber gloves, clothing protection and safety goggles while performing all cleaning and sanitation procedures.

CLEANING SOLUTION

A Sanitizing agent capable of providing 100 PPM of available chlorine when properly mixed with 110° to 120° F or 45° to 50° C warm water is required. Always be certain to follow the sanitizer manufacturer's instructions for proper dilution to produce a 100 PPM chlorinating sanitizer solution when mixed with water.

Examples of sanitizers with 100 PPM available chlorine are: Kay 5 Sanitizer (Wunder-Bar p/n Kay-5), by Kay Chemicals division of Ecolab, Inc., or B-T-F Chloromelamine Disinfectant (Wunder-Bar p/n CD-SA-8), by National Chemicals, Winona, MN. Mix one packet of Kay-5 or B-T-F sanitizer powder per 2-1/2 gallons of warm water (110° F or 45° C) and mix thoroughly with paddle or wooden spoon.

PREPARATION:

Follow the manufacturer's instructions for proper dilution of their sanitizing agent that is necessary to produce a 100 PPM chlorinated cleaning solution when mixed with 5 gallons of warm water (110° F or 45° C). Mix sanitizing agent and water thoroughly with paddle or wooden spoon.

CLEANING PROCEDURE

WASH

1. Fill a 5 gallon bucket with Cleaning Solution (See above for Cleaning Solution Preparation).
2. Disconnect any BIB syrup connectors from the BIB(s).
3. Connect the first BIB connector to the Sanitizer Adapter. Fully actuate the connector by pushing the center plunger into the Sanitizer Adapter fully or screwing in the Sanitizer Adapter all the way into the BIB connector.
4. Place the BIB connector with the appropriate Sanitizer Adapter installed into the pail or bucket of Cleaning Solution.
5. Place a catch container under the dispenser's nozzle.
6. Enter the "Service Screen".
7. PRESS and HOLD the associated (Syrup) Circuit's PRIME Button to flow the Cleaning Solution through the entire dispensing system and Mustang Tower until a minimum of 1/2 gallon of Cleaning Solution has been dispensed from the nozzle into the catch container.
8. Allow the Cleaning Solution to remain in the system for a minimum of two minutes.

RINSE

9. Fill a 5 gallon bucket with Cleaning Solution (See above for Cleaning Solution Preparation).
10. PRESS and HOLD the associated (Syrup) Circuit's PRIME Button until a minimum of one quart of Cleaning Solution has been dispensed from the nozzle into the catch container.

SANITIZE

11. Fill a 5 gallon bucket with Cleaning Solution (See above for Cleaning Solution Preparation).
12. PRESS and HOLD the same (Syrup) Circuit's PRIME Button until a minimum of 1 quart of Cleaning Solution has been dispensed into the catch container.
13. Remove the BIB Connector and Adapter from the Cleaning Solution and again PRESS and HOLD the same (Syrup) Circuit's PRIME Button until the remaining Cleaning Solution is dispensed.
14. Install the BIB Connector onto the correct Syrup Container.
15. PRESS and HOLD the associated (Syrup) Circuit's PRIME Button until pure syrup product is observed dispensing from the Mustang Tower's nozzle. Then dispense a minimum of three (3) ounces of syrup to assure the product dispensed contains no Cleaning Solution.
16. PRESS "EXIT" to exit Service Screen.

Wunder-Bar™

NOZZLE, DIFFUSER, and MUSTANG CLEANING INSTRUCTIONS

EQUIPMENT NECESSARY

- Clean 2-1/2 to 5 gallon pail or bucket (1)
- Clean cloth towel (1)
- Safety goggles and rubber gloves

WARNING!

DO NOT USE LAUNDRY TYPE LIQUID BLEACH AS A SANITIZER!!

CAUTION: Chlorinated Sanitizers are corrosive. Wear rubber gloves, clothing protection and safety goggles while performing all cleaning and sanitation procedures.

CLEANING SOLUTION

A Sanitizing agent capable of providing 100 PPM of available chlorine when properly mixed with 110° to 120° F or 45° to 50° C warm water is required. Always be certain to follow the sanitizer manufacturer's instructions for proper dilution to produce a 100 PPM chlorinating sanitizer solution when mixed with clean water.

Examples of sanitizers with 100 PPM available chlorine are: Kay 5 Sanitizer (Wunder-Bar p/n Kay-5), by Kay Chemicals division of Ecolab, Inc., or B-T-F Chloromelamine Disinfectant, (Wunder-Bar p/n CD-SA-8) by National Chemicals, Winona, MN. Mix one packet of Kay-5 or B-T-F sanitizer powder per 2-1/2 gallons of warm water (110° F or 45° C) and mix thoroughly with paddle or wooden spoon

PREPARATION:

Follow the manufacturer's instructions for proper dilution of their sanitizing agent that is necessary to produce a 100 PPM chlorinated cleaning solution when mixed with 5 gallons of warm water (110° F or 45° C). Mix sanitizing agent and water thoroughly with paddle or wooden spoon.

Recommended Daily Procedures

1. Prepare 2-1/2 gallons of Cleaning Solution in a pail or bucket (See above for Cleaning Solution Preparation).
2. Unplug the dispenser or turn the dispenser off.
3. Twist and remove the nozzle and place in Cleaning Solution for 2 minutes. Scrub nozzle and diffuser with a clean brush until any buildup is removed.
4. Remove the nozzle from Cleaning Solution. Allow the nozzle and diffuser to air dry.
5. Remove the cup rest from the drip tray and rinse it thoroughly with warm tap water.
6. Remove drip tray and rinse with potable water.
7. Wipe the outside of the Mustang Tower down with a clean cloth soaked in the Cleaning Solution. **(Do not use Cleaning Solution or any other chlorinated or corrosive cleaning product on the dispensing Mustang Tower's display panel. Only use lens cleaner or properly diluted non-chlorinated, mild detergent solution to clean the display panel).**
8. Reinstall the nozzle onto the diffuser.
9. Reinstall the cup rest and drip tray.
10. Plug the dispenser in and move the power switch to the on position.
11. Dispense a beverage to confirm the Mustang Tower is operating properly.

Wunder-Bar™

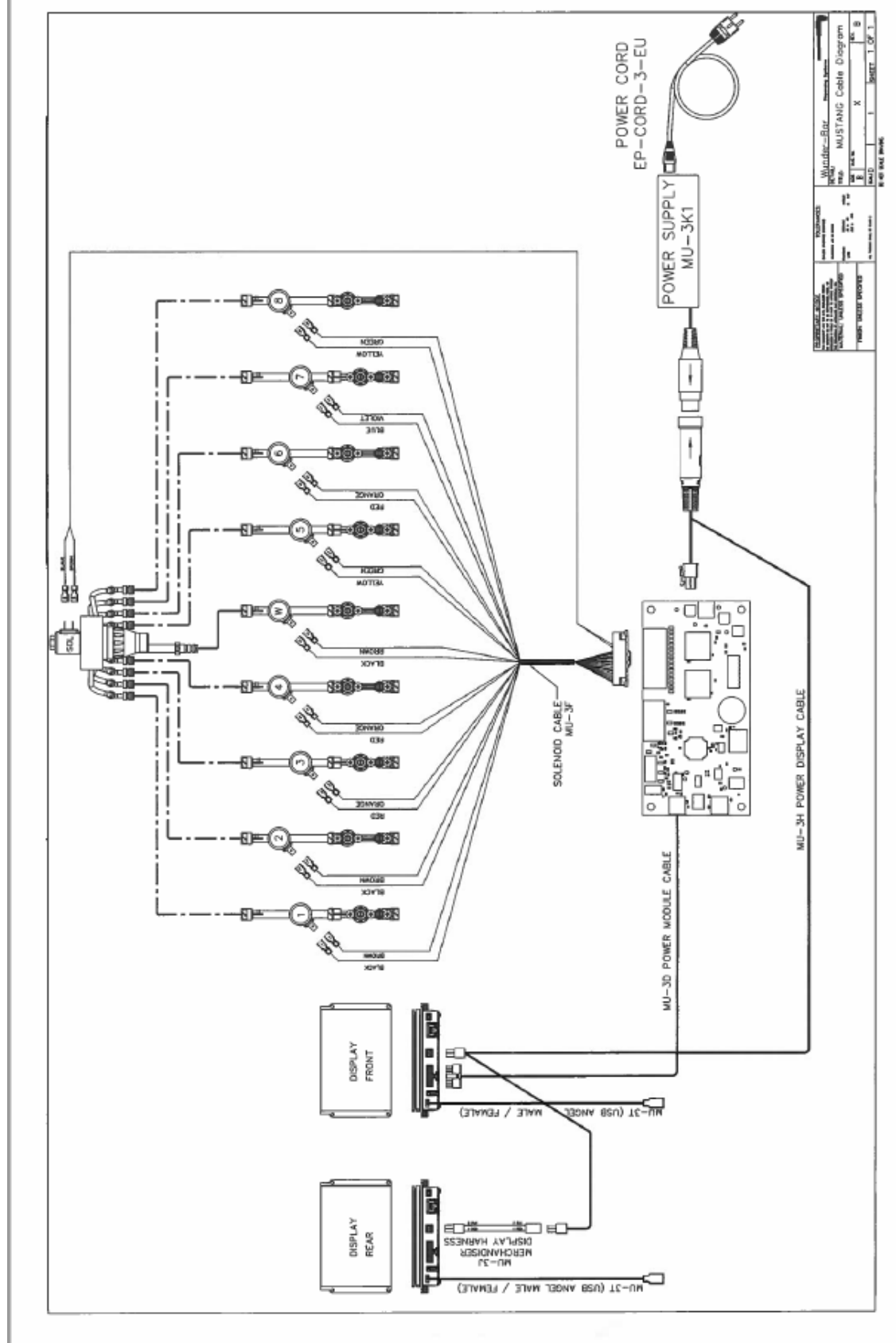

Wunder-Bar™

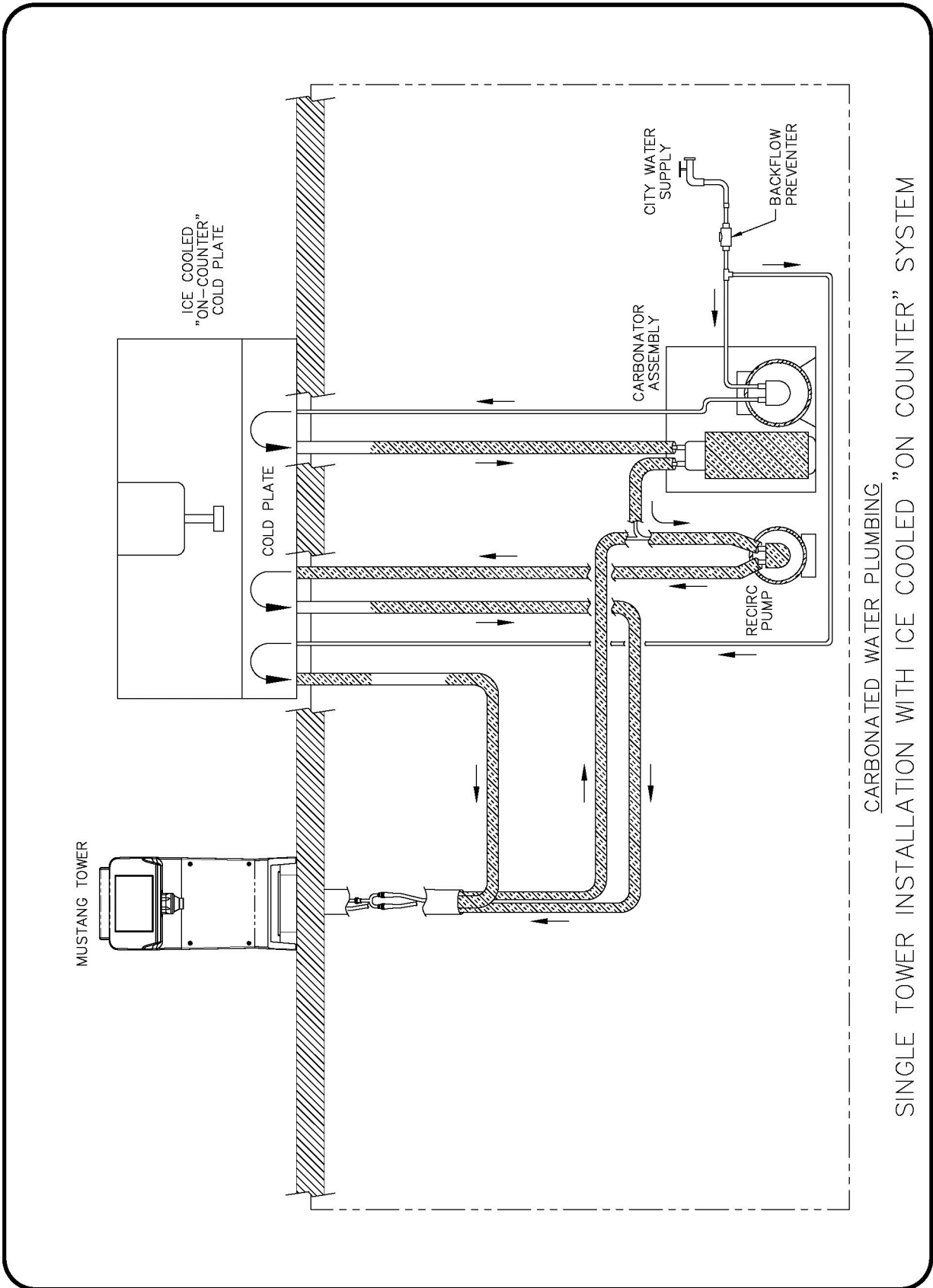

Wunder-Bar™

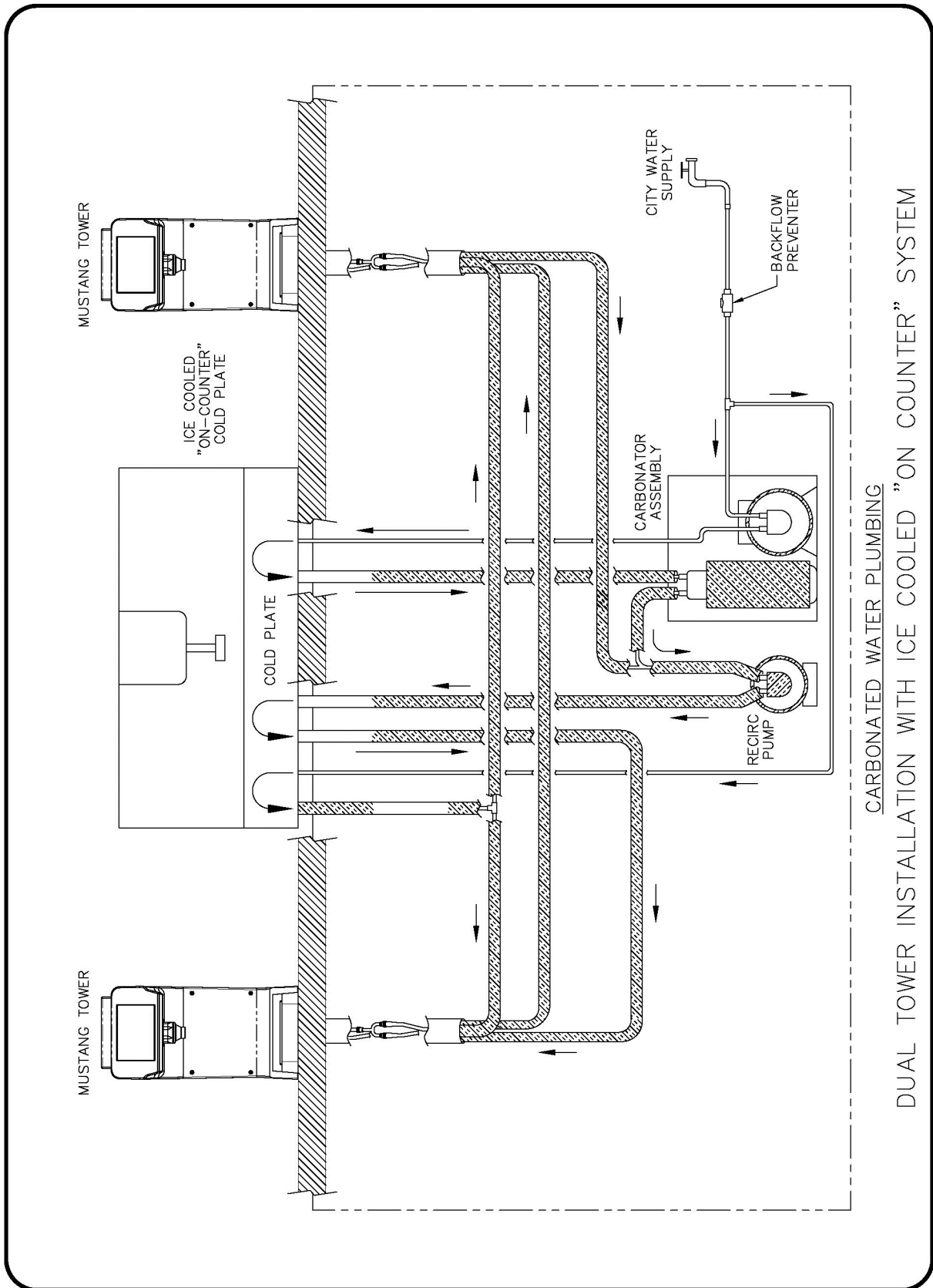

Wunder-Bar™

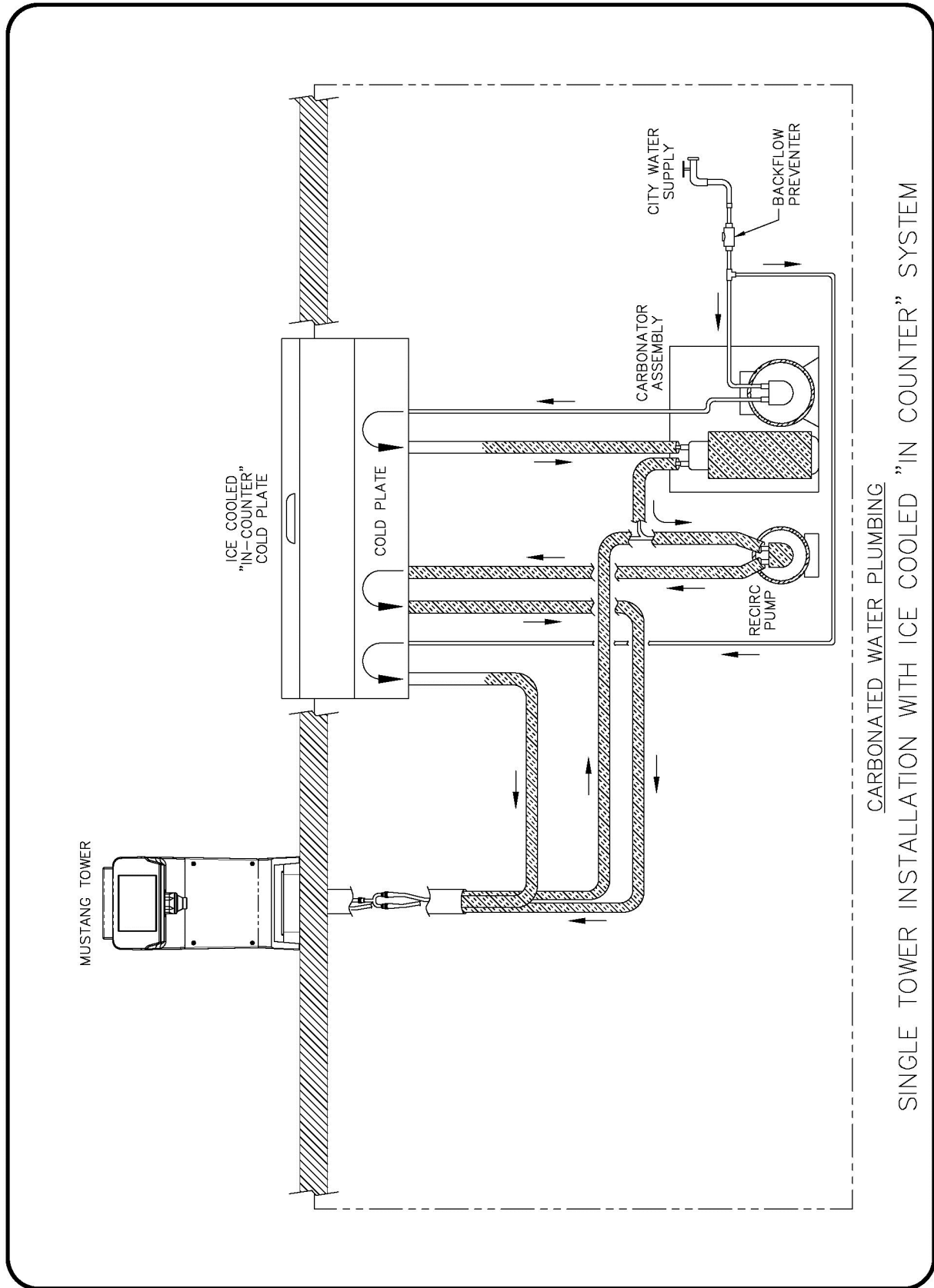

Wunder-Bar™

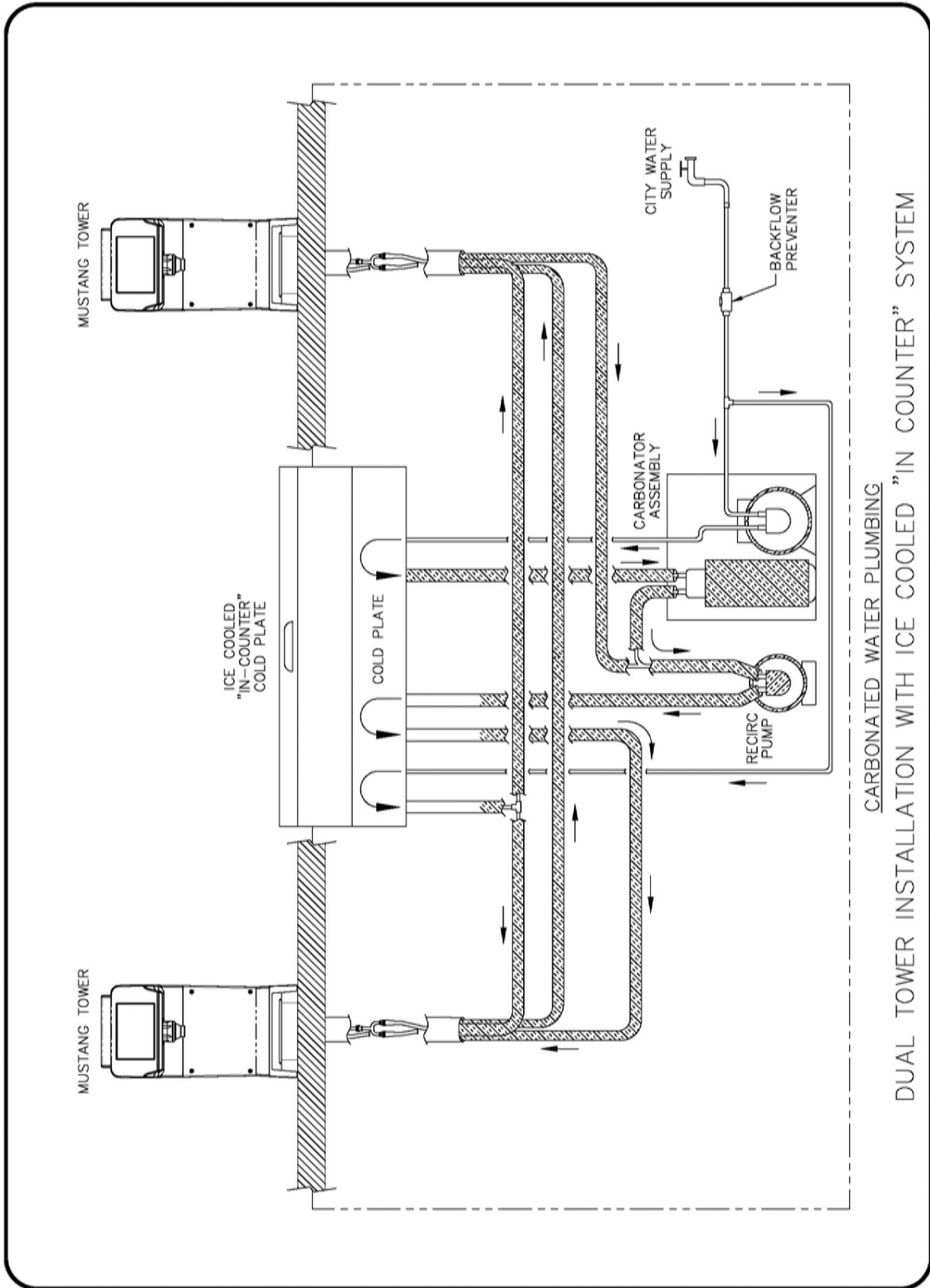

Wunder-Bar™

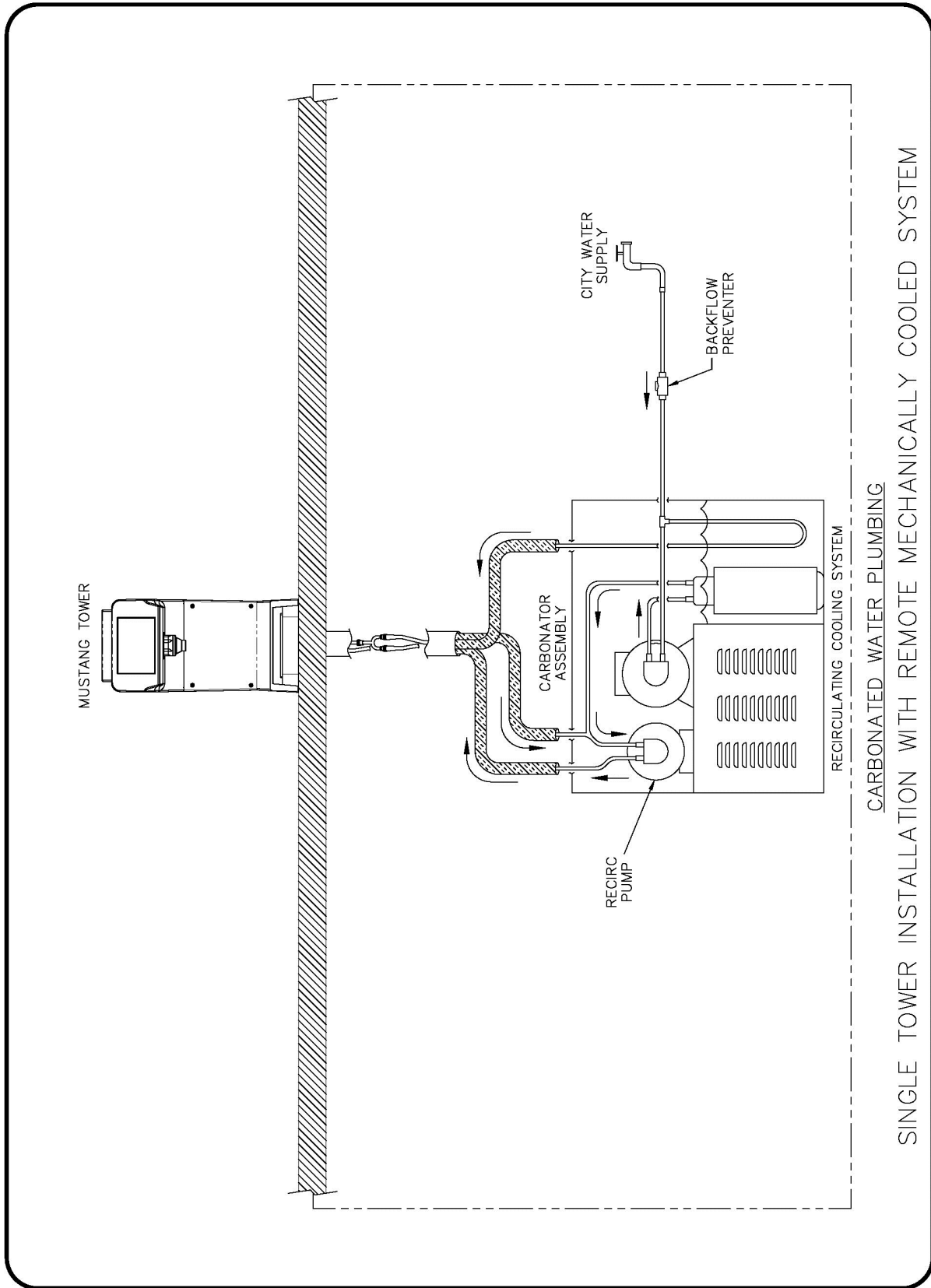

Wunder-Bar™

